

-  Istruzioni di montaggio
-  Installation Instruction
-  Instruction de montage
-  Montageanleitung
-  Instrucciones de montaje



Treemme  
Rubinetterie



**Art. IT2C11/18/22\_\_AUZZ**

MISCELATORE MONOCOMANDO LAVABO / BIDET

WASHBASIN / BIDET MIXER

MITIGEUR LAVABO / BIDET

EINHAND-WASCHTISCHMISCHER / BIDET-MISCHER

MONOMANDO PARA LAVABO / BIDE'



**SCAN TO WATCH**

Treemme\_tech

QR N°70



Certified to  
NSF/ANSI 61





## IT

Grazie per aver scelto Rubinetterie Treemme. Perché il Suo rubinetto funzioni correttamente e possa durare nel tempo, occorre che vengano rispettate le procedure di installazione ed manutenzione illustrate in questo opuscolo.

## EN

Thank you for choosing Rubinetterie Treemme. In order to ensure that your tap works properly and it lasts over time, you must carefully observe our installation instruction and care and maintenance procedures described on this brochure.

## FR

Nous vous remercions d'avoir choisi Rubinetterie Treemme. Pour que votre robinet fonctionne d'une manière correcte et puisse durer longtemps, il est convenable de respecter les modalités et d'installation et d'entretien indiqués dans cette notice.

## DE

Vielen Dank, dass Sie sich für Rubinetterie Treemme entschieden haben. Weil Ihr Wasserhahn funktioniert Wenn Sie die in dieser Broschüre beschriebenen Installations- und Wartungsvorgänge einhalten, müssen sie beachtet werden.

## SP

Gracias por elegir Rubinetterie Treemme. Para que su grifo funcione correctamente y para que sea duradero, es necesario el respeto de los procedimientos de instalación y de mantenimiento que se describen en este folleto.



## FR

**On recommande de purger les tubes d'alimentation avant de placer le produit**

## IT

**Si raccomanda prima di installare il prodotto di spurgare accuratamente i tubi di alimentazione**

## DE

**Es ist empfohlen bevor den Artikel zu installieren die Zuleitungsrohre zu spülen**

## EN

**It is suggested to purge the inlet tubes before to install the product**

## SP

**Enjaguar con mucha atención los tubos de alimentación antes de conectar el producto**

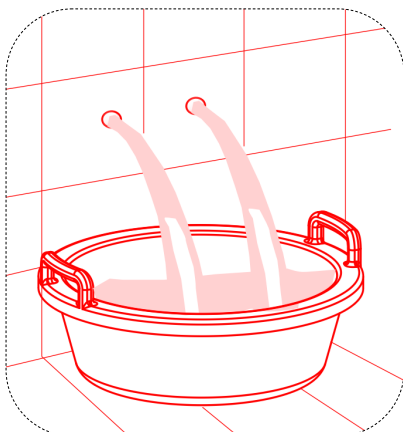

- INSTALLAZIONE / INSTALLATION P\_4
  
- CURA DELL'AERATORE / AERATOR CARE P\_9
  
- SOSTITUZIONE CARTUCCIA / CARTRIDGE REPLACEMENT P\_10

INSTALLAZIONE—INSTALLATION

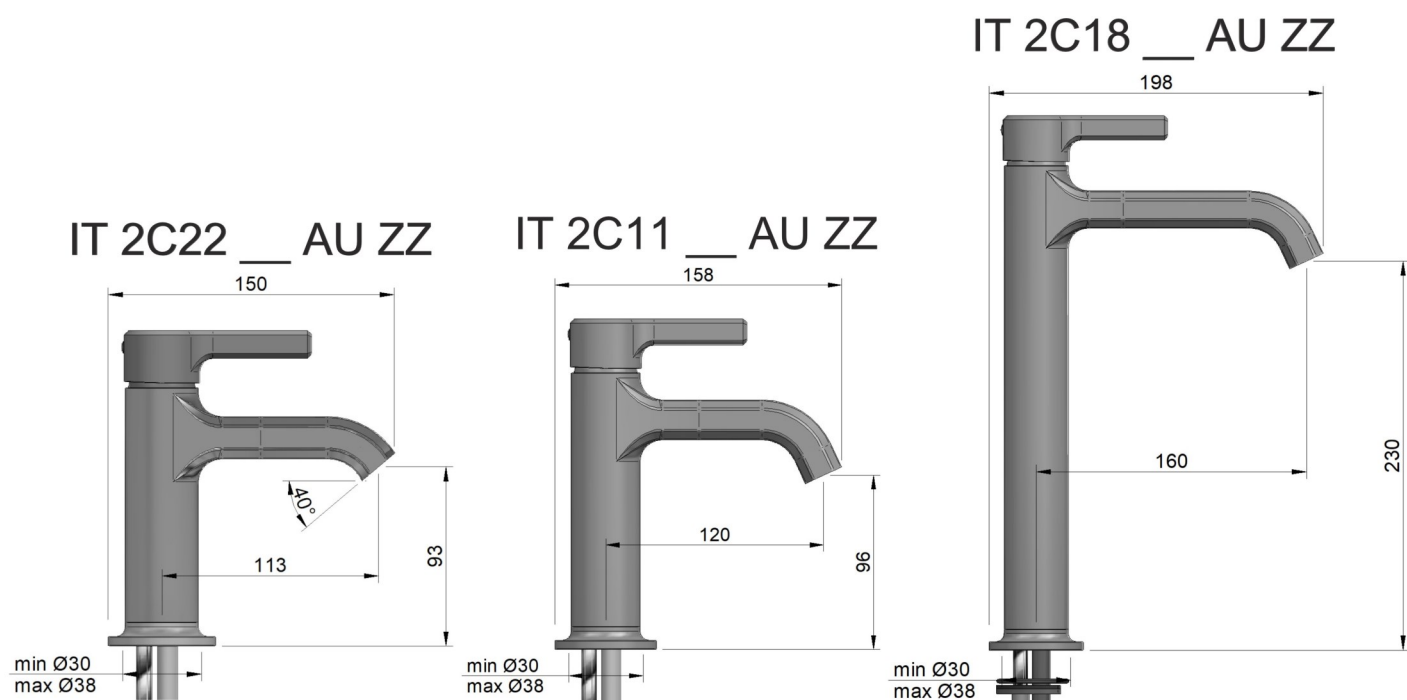

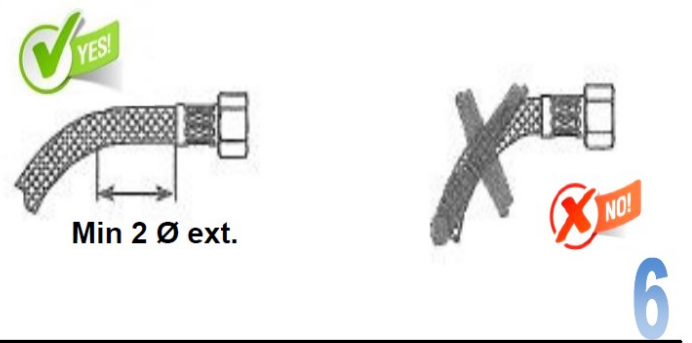
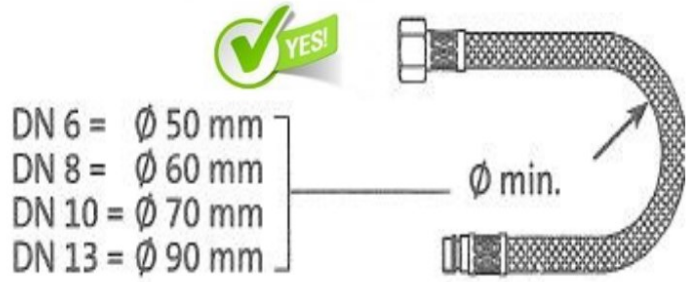
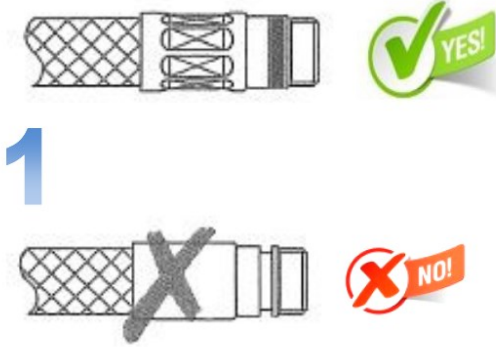

INSTALLAZIONE  
INSTALLATION  
MONTAGE  
POSE  
INSTALACIÓN

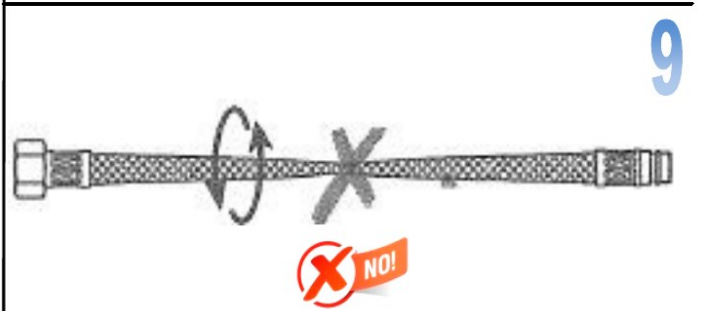
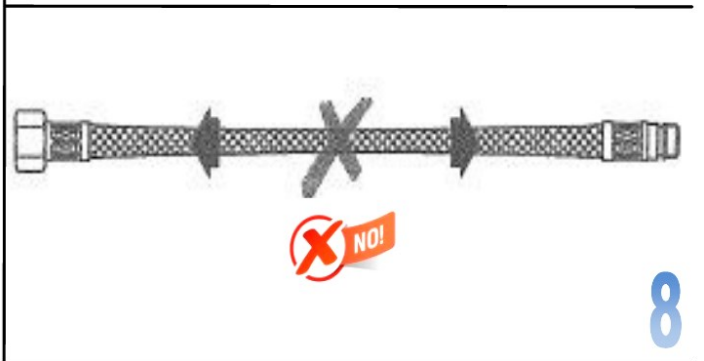

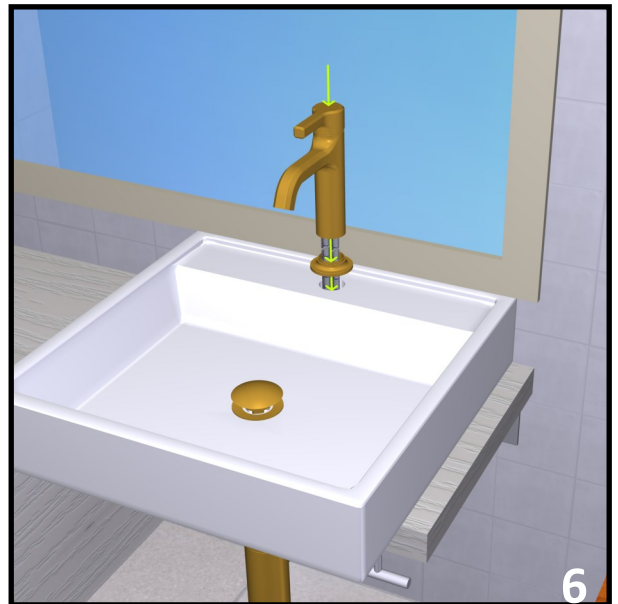
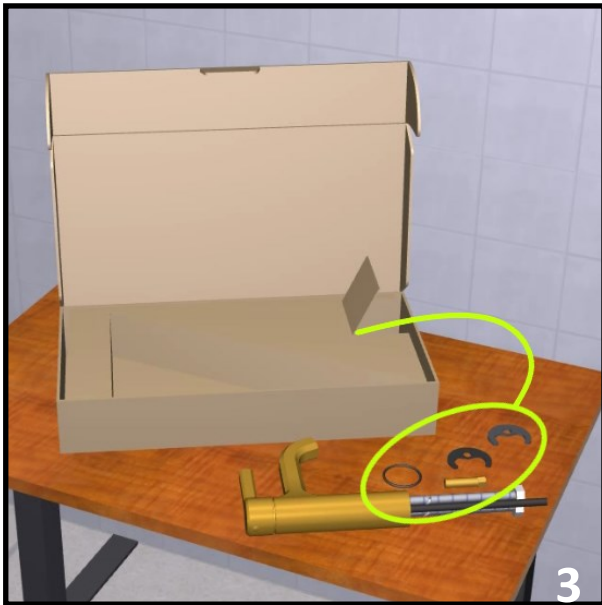

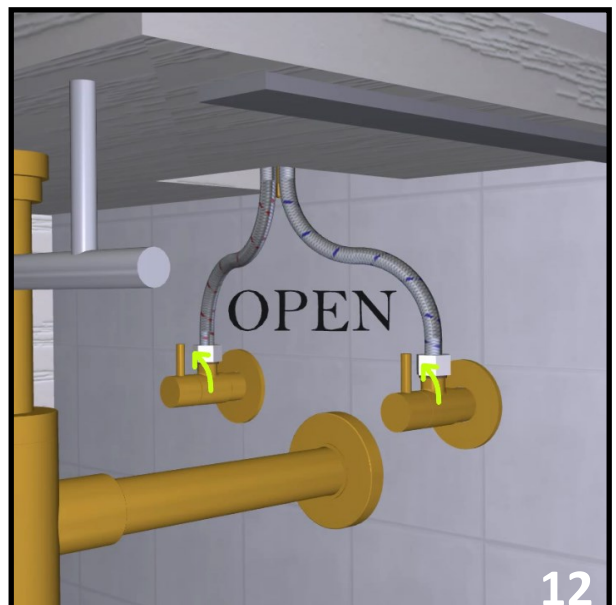
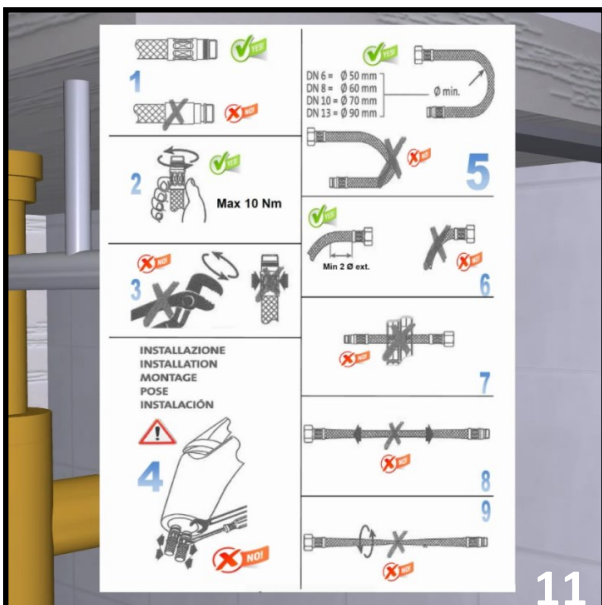
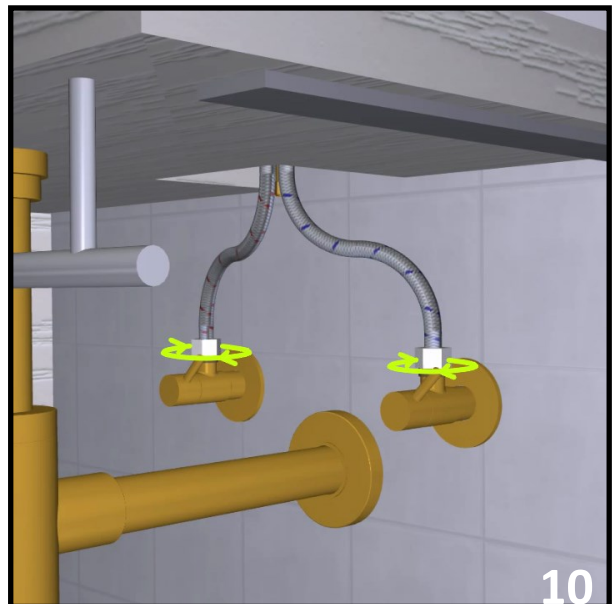
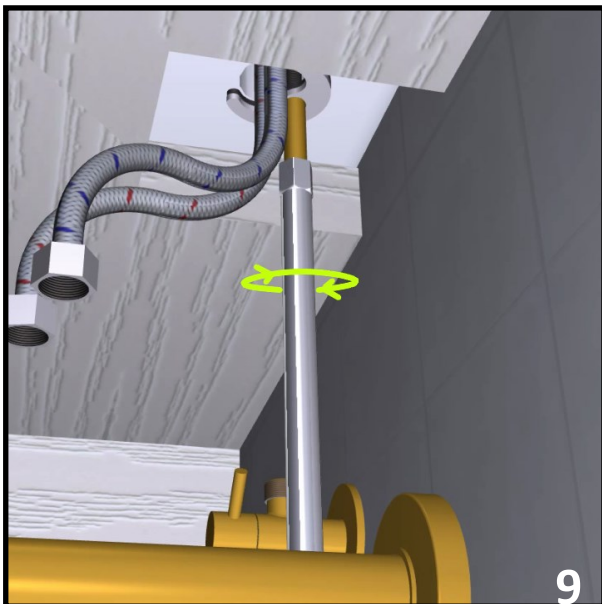
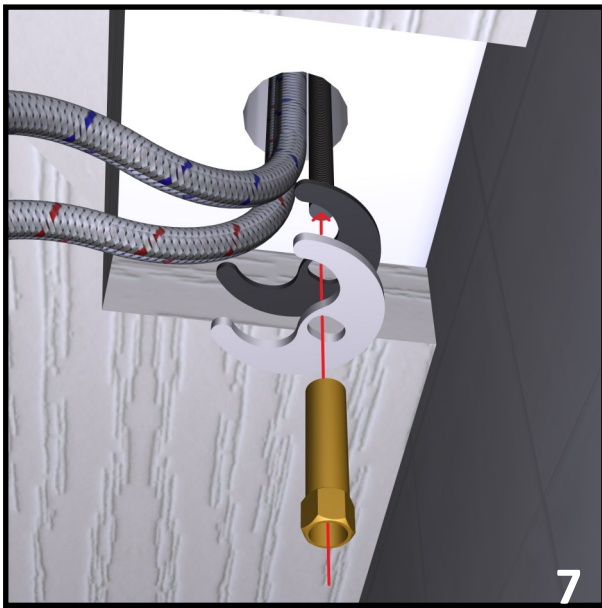

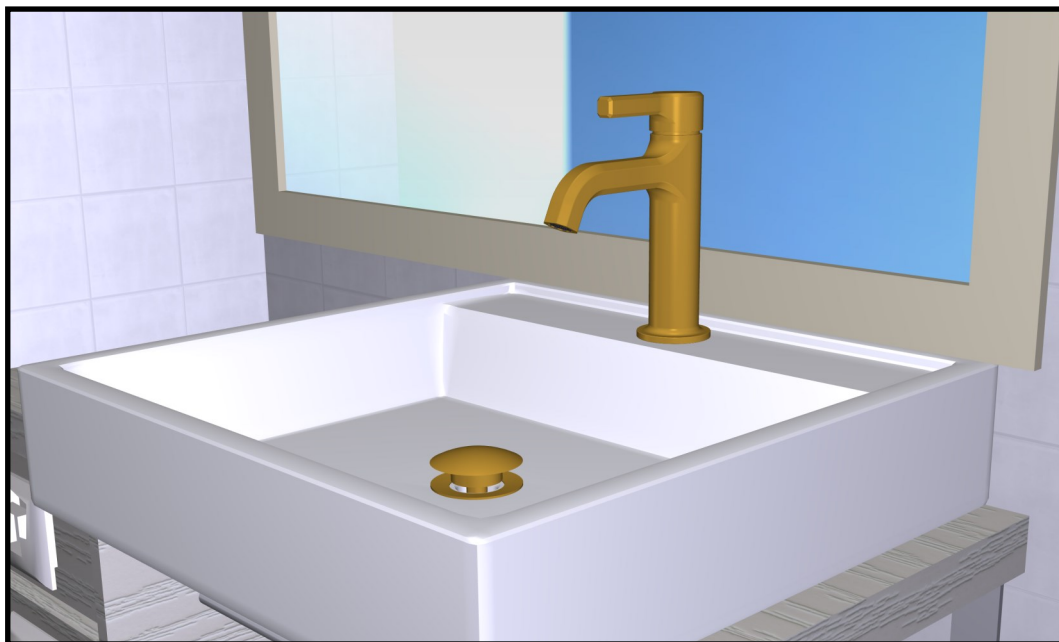





Cura dell'aeratore

Aerator care

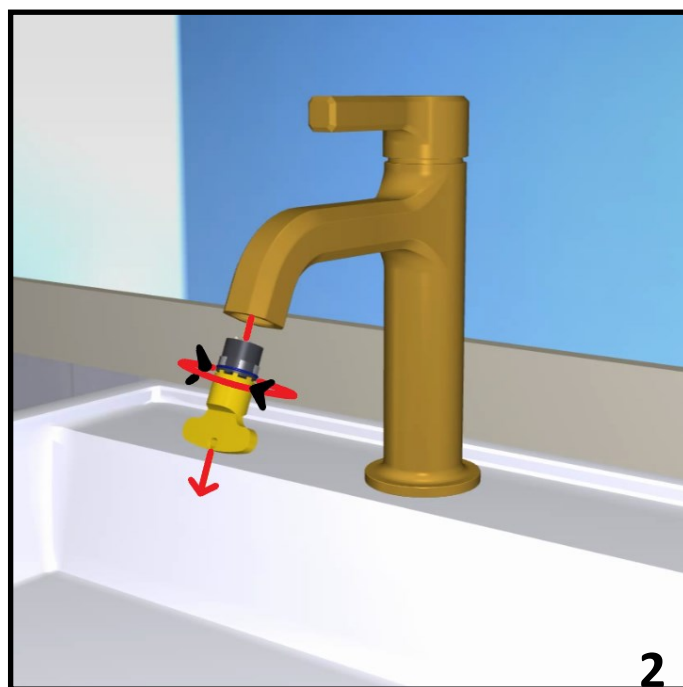
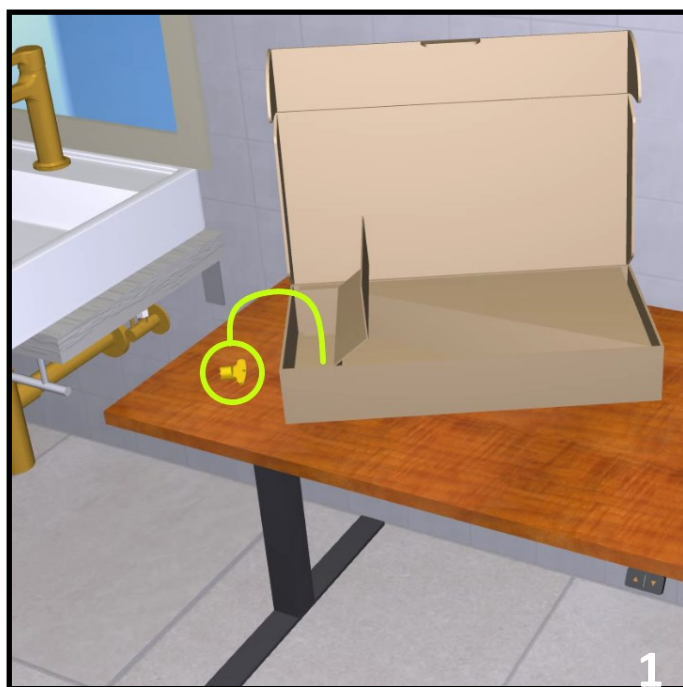

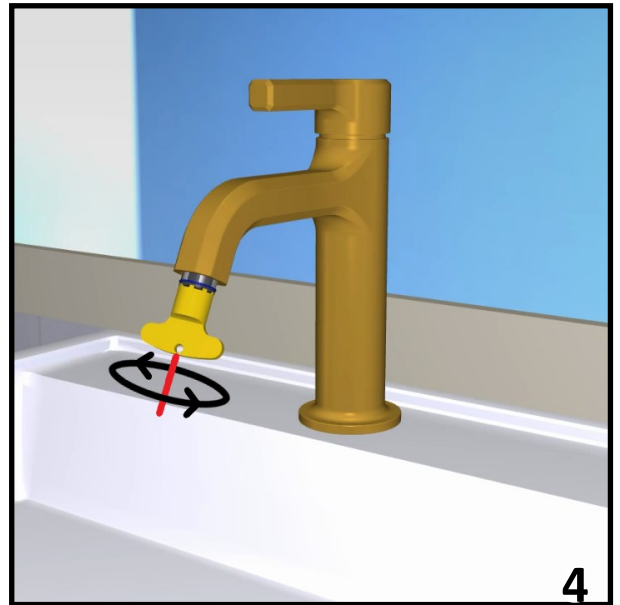
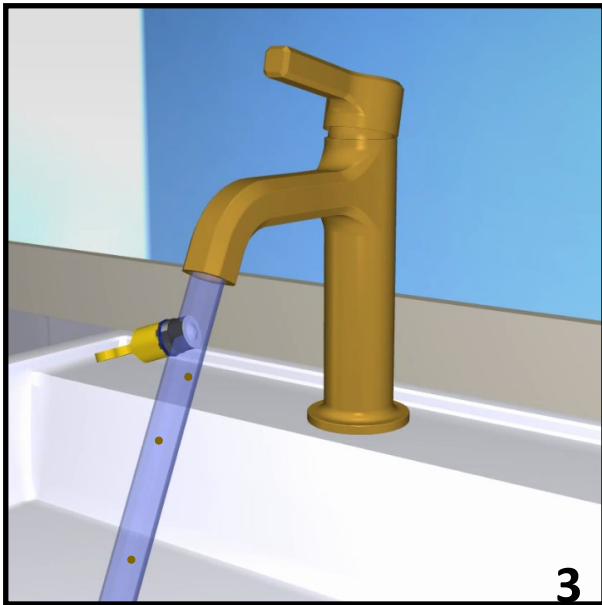

SOSTITUZIONE CARTUCCIA—CARTRIDGE REPLACEMENT

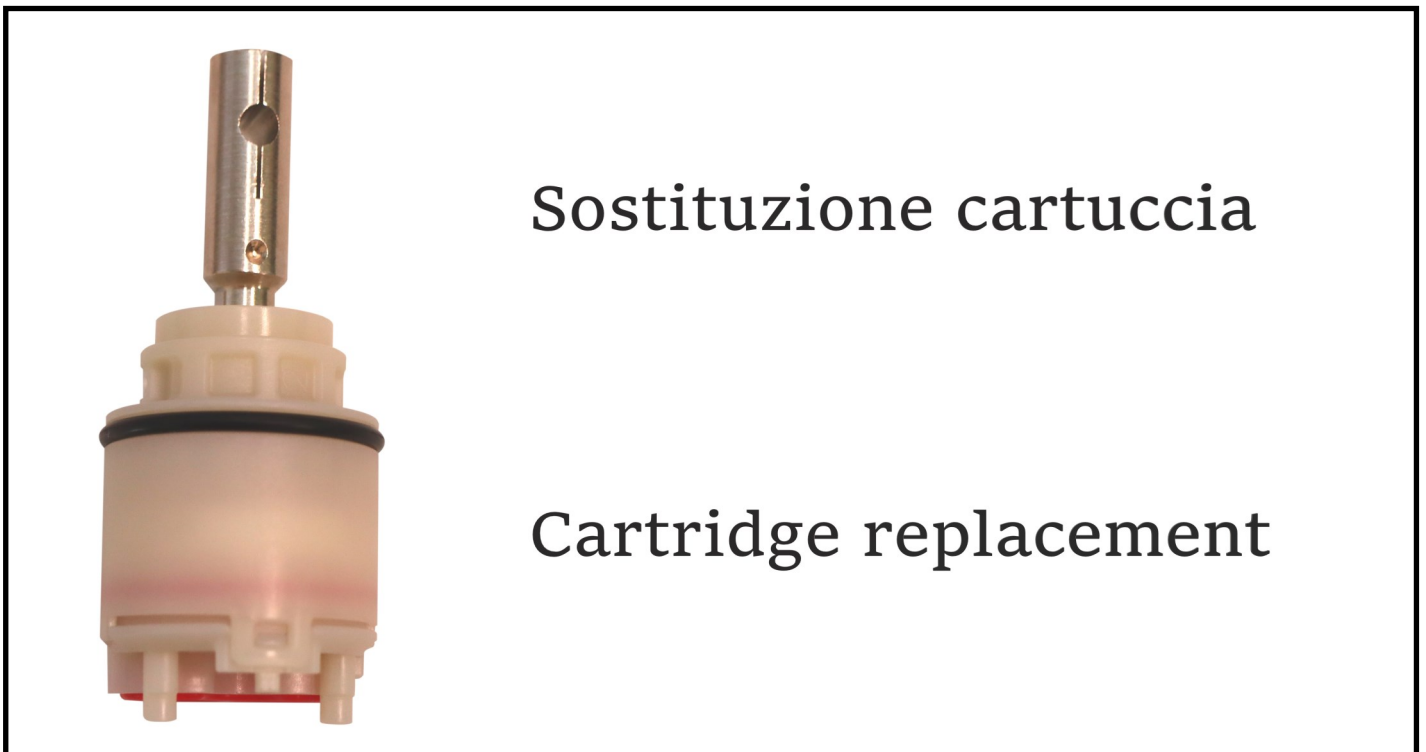

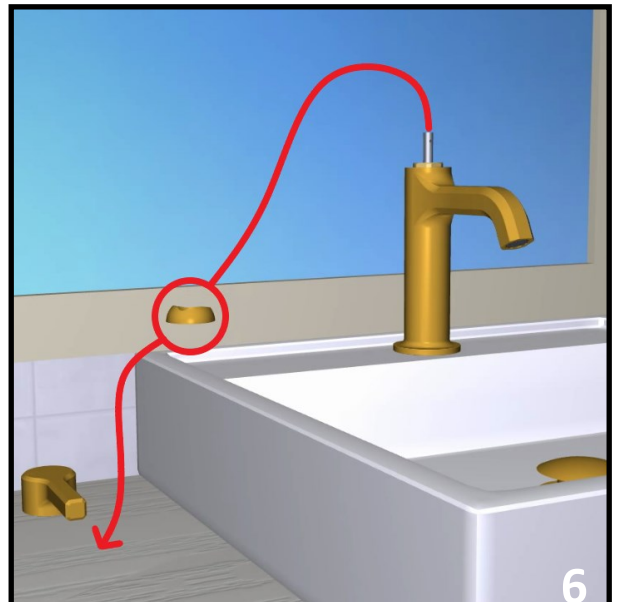
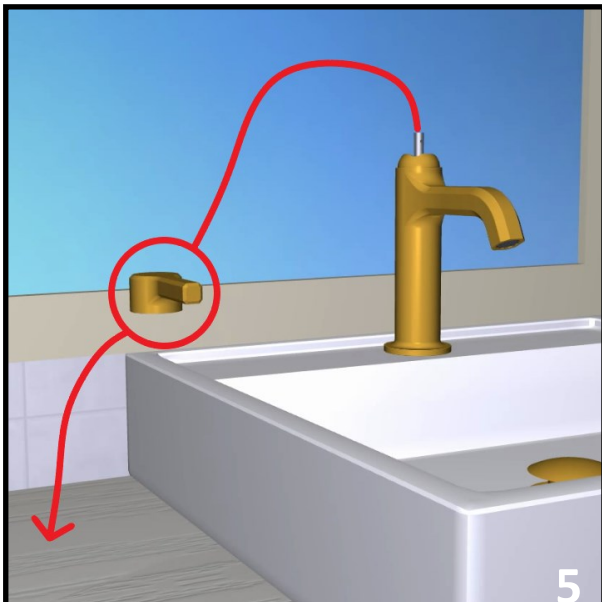
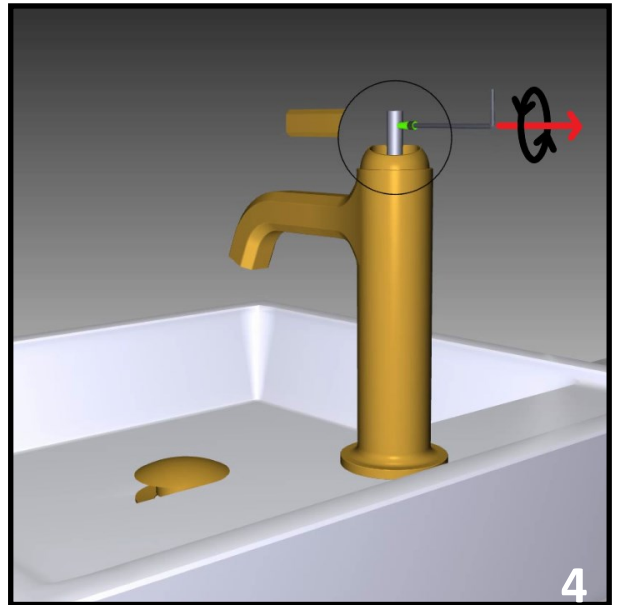
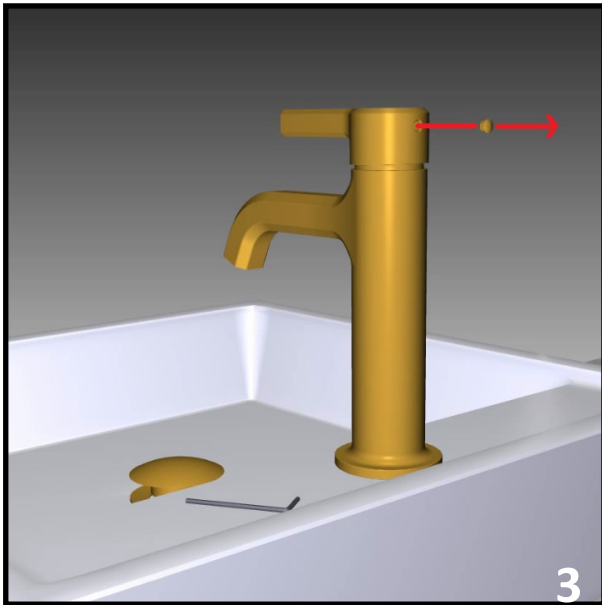
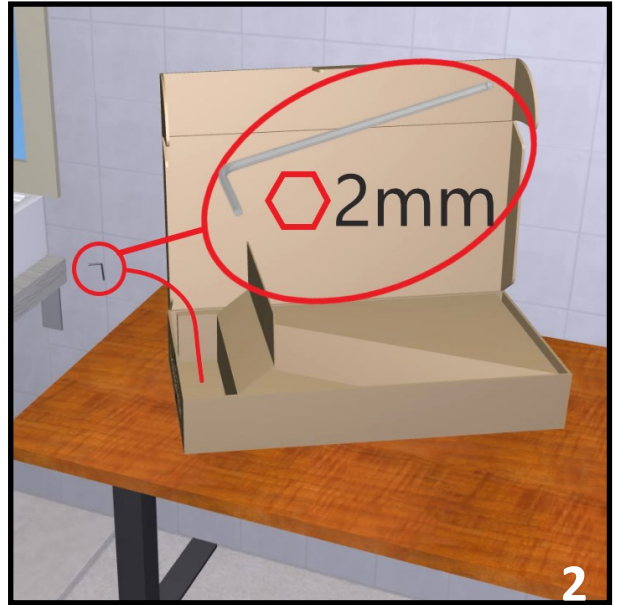
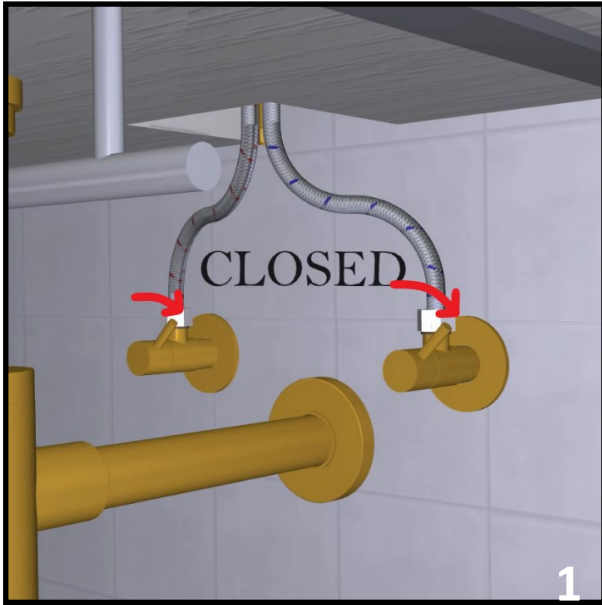

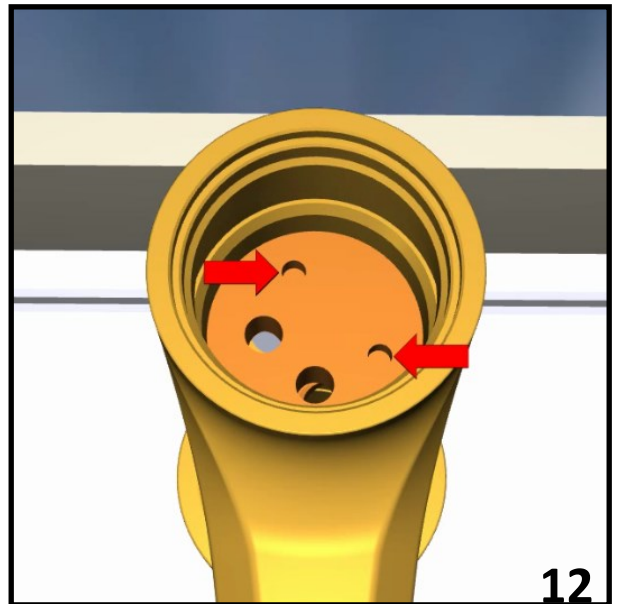
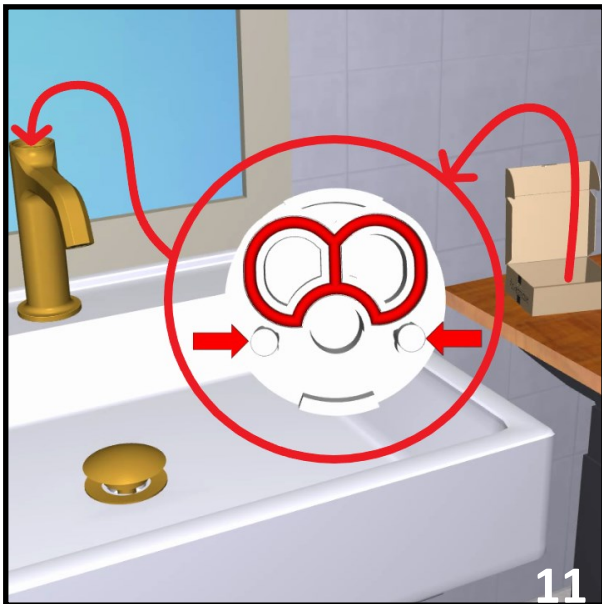
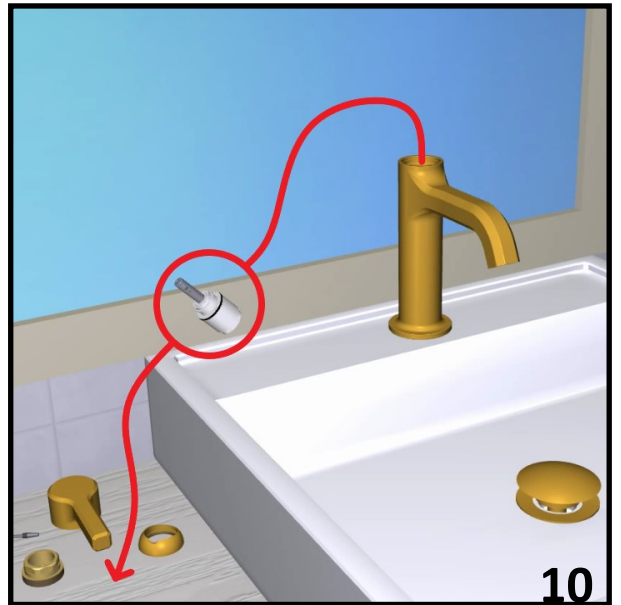
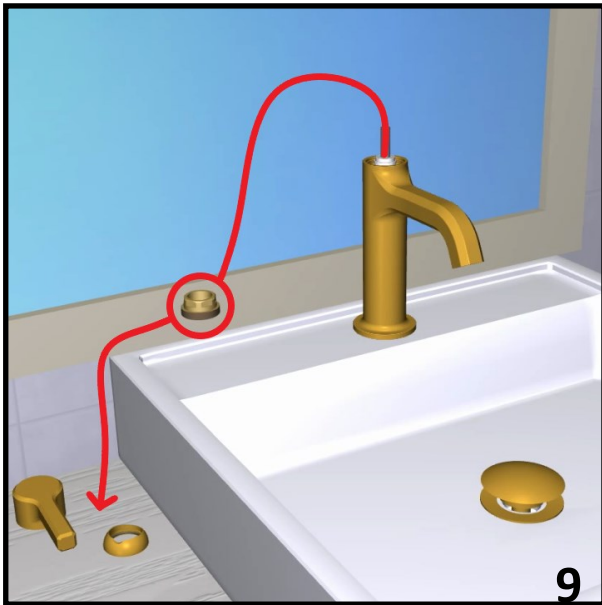
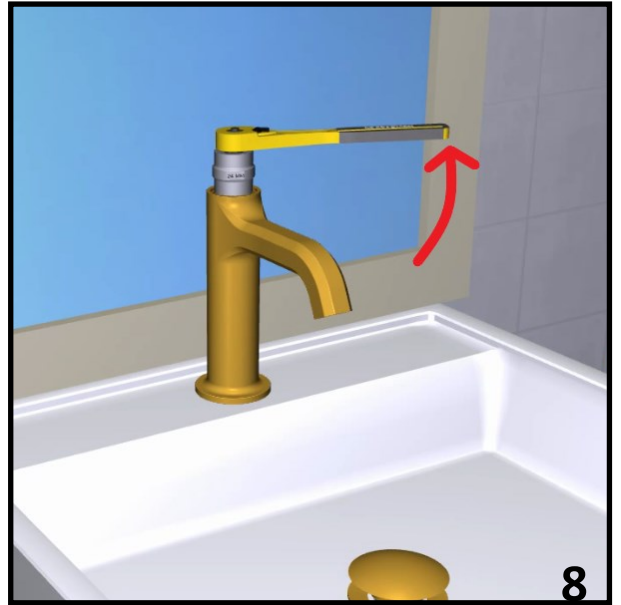
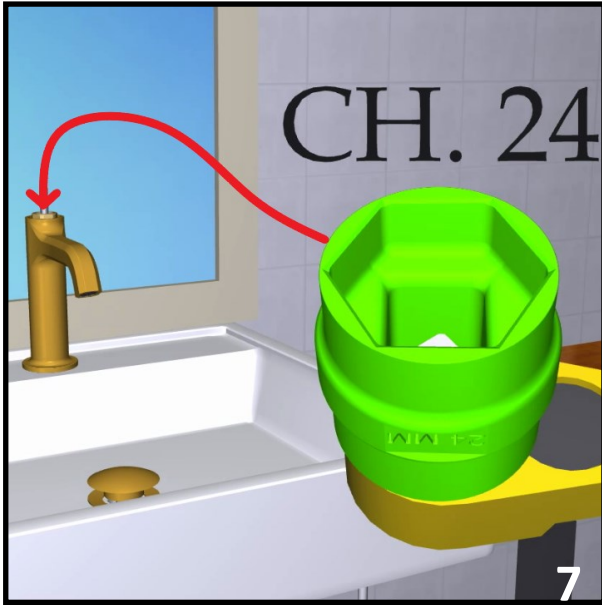

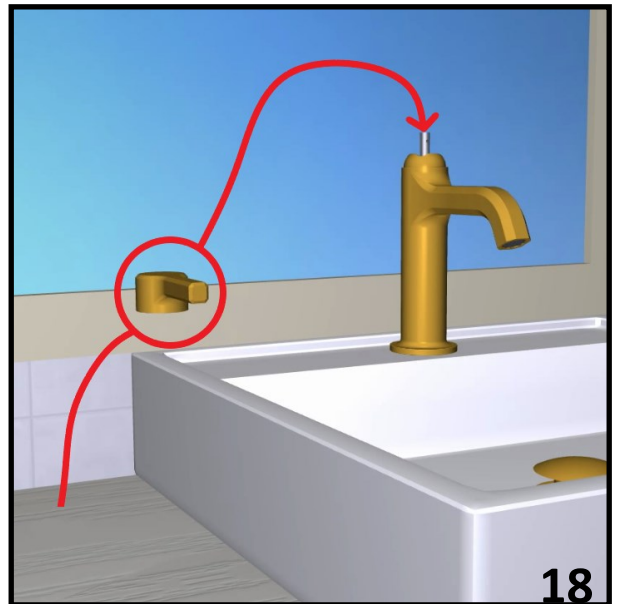
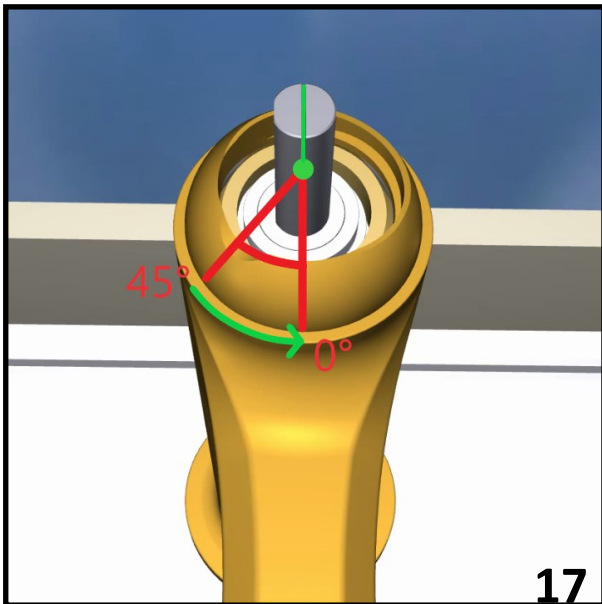
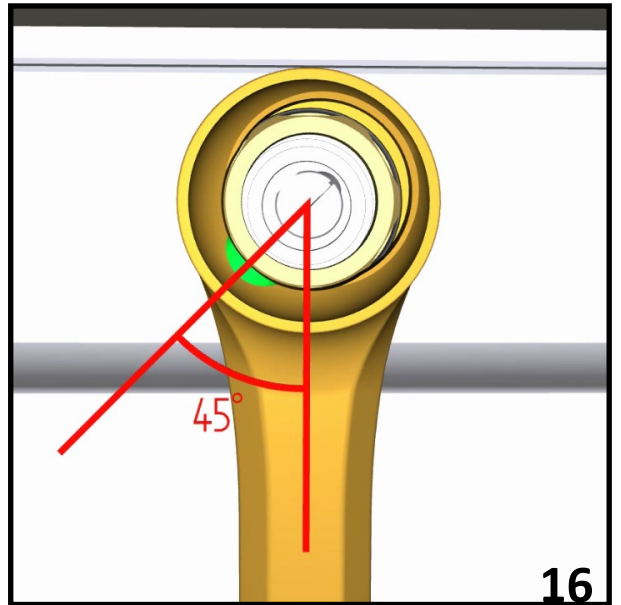
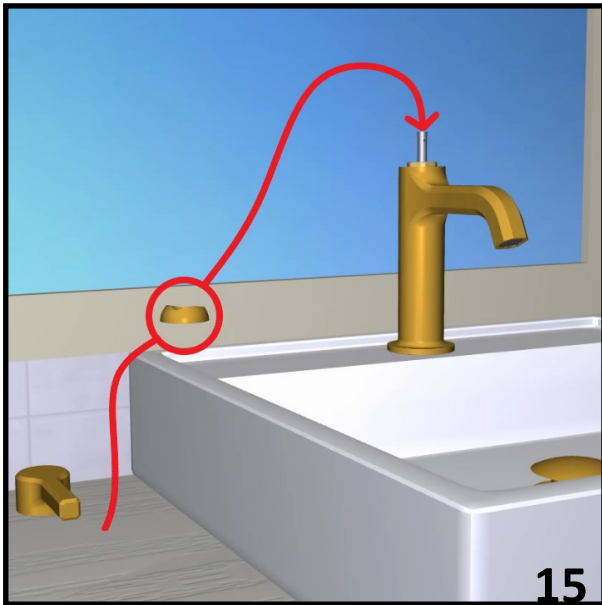
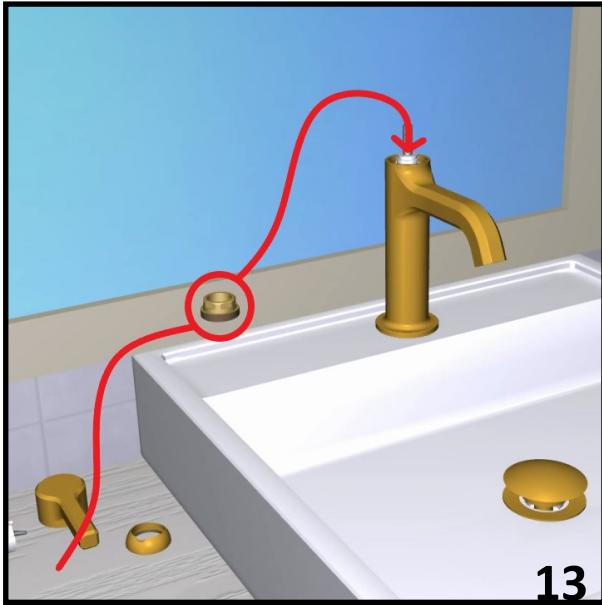

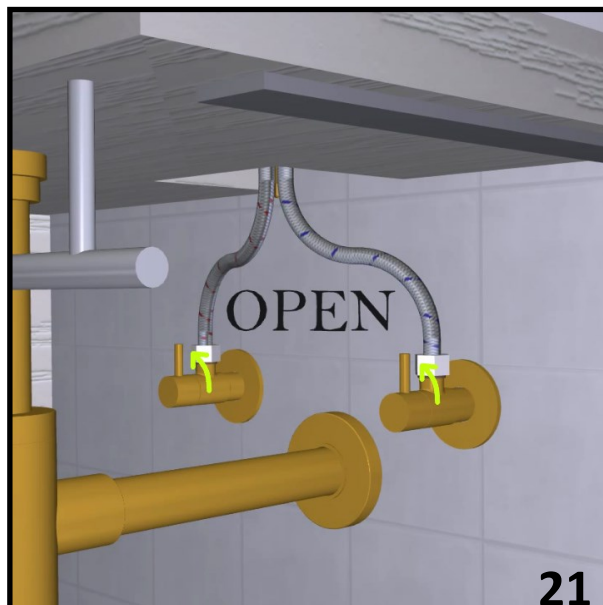
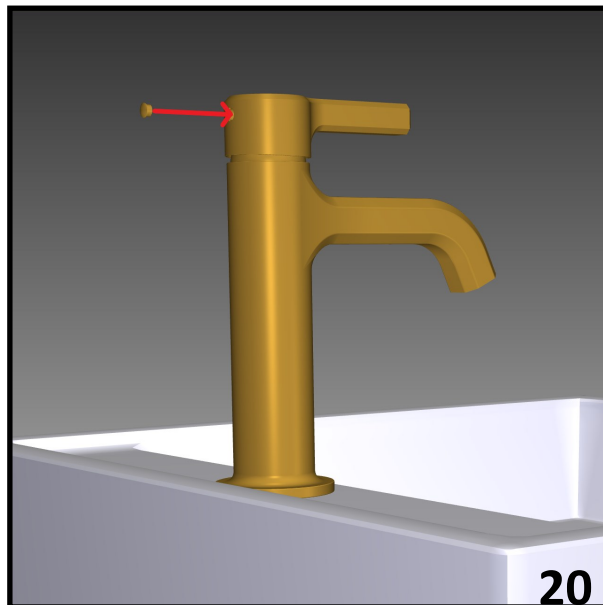
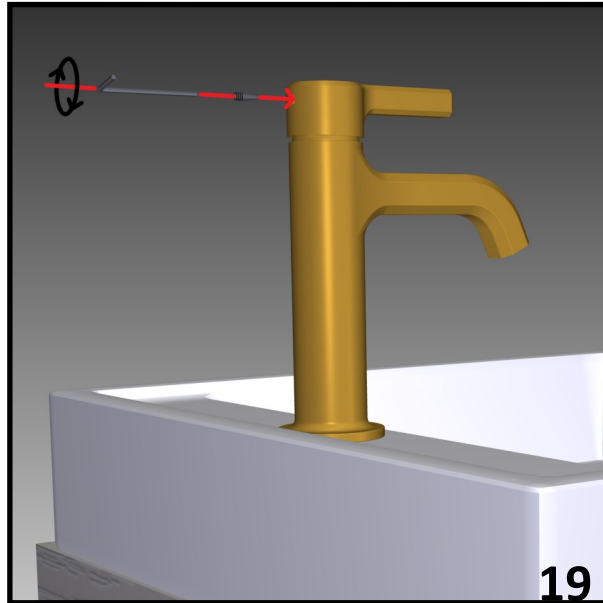



RUBINETTERIE  
treemme  
*instruments for water*