

| E044107 |

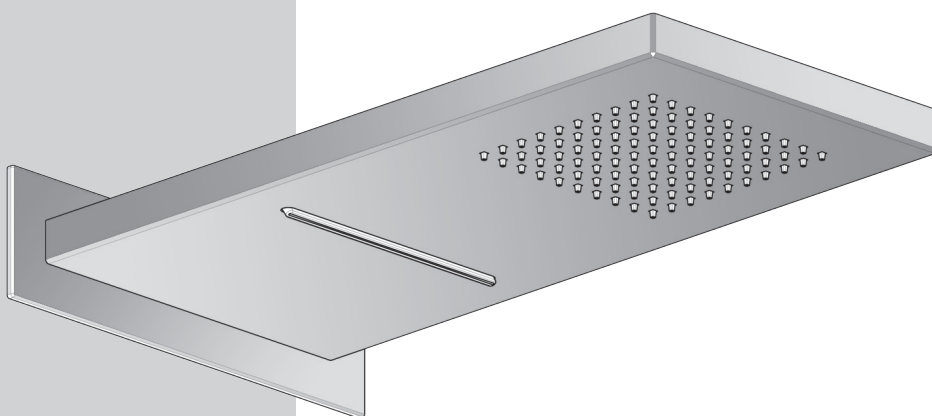

| E044108 |



	E044107	E044108
	X1	-
	-	X1
	X1	X1
	X1	-
	-	X1
Ø 12 mm	X4	X4
	X2	X2
	X2	X2
	X2	X2
	X6	X6
	X2	X2
<ul style="list-style-type: none"> IT Istruzioni di montaggio GB Mounting instructions FR Instructions de montage DE Montageanweisungen ES Instrucciones de montaje 	X1	X1

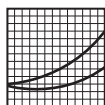

IT | Diagramma di flusso
GB | Flow rate
FR | Le débit
DE | Flussdiagramm
ES | Diagrama de caudal



IT | Indossare protezioni
GB | Wear protection
FR | Porter une protection
DE | Schütze anziehen
ES | Usar protección

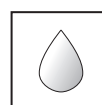

IT | Caratteristiche idrauliche
GB | Plumbing specifications
FR | Caracteristiques hydrauliques
DE | Hydraulische Eigenschaften
ES | Características hidráulicas



IT | Pressione d'uso
GB | Operating pressure
FR | Pression d'utilisation
DE | Betriebsdruck
ES | Presión de uso



IT | Temperatura dell'acqua
GB | Water temperature
FR | Température de l'eau
DE | Wassertemperatur
ES | Temperatura del agua

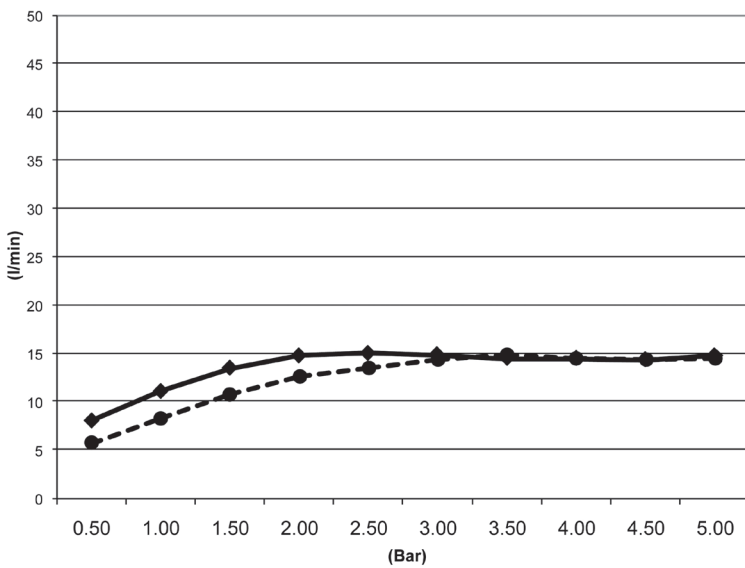
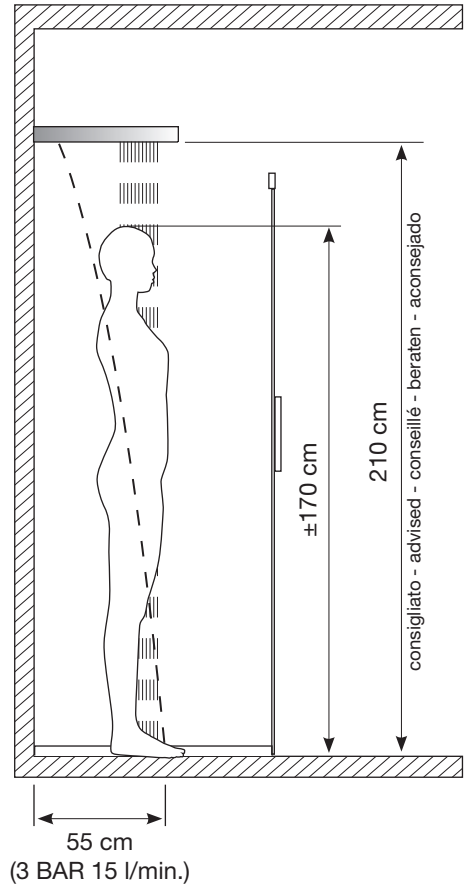
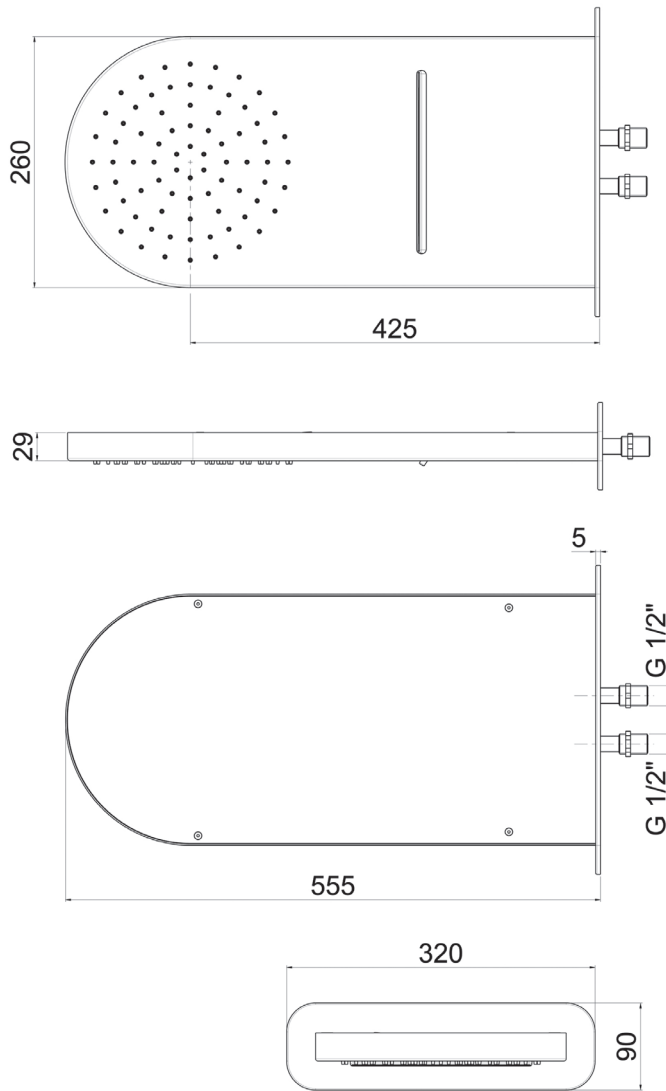

- ◆— IT | Portata l/m cascata
- GB | l/m waterfall flow
- FR | Débit l/m cascade
- DE | l/m Wasserfallfluss
- ES | Caudal l/m cascada

- ◆- IT | Portata l/m pioggia
- GB | l/m rain flow
- FR | Débit l/m pluie
- DE | l/m Regenfluss
- ES | Caudal l/m lluvia

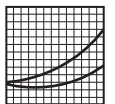

Pressione Dinamica (bar) / Portata (Litri/min)	
Bar	0,50 1,00 1,50 2,00 2,50 3,00 3,50 4 4,5 5
—◆—	8,1 11,2 13,5 14,8 15,1 14,9 14,5 14,5 14,4 14,8
-◆-	5,7 8,3 10,8 12,6 13,5 14,4 14,9 14,5 14,4 14,5

MIN 1 Bar

MAX 5 Bar

BEST 3 Bar

MAX 70° C

BEST 38°/40° C

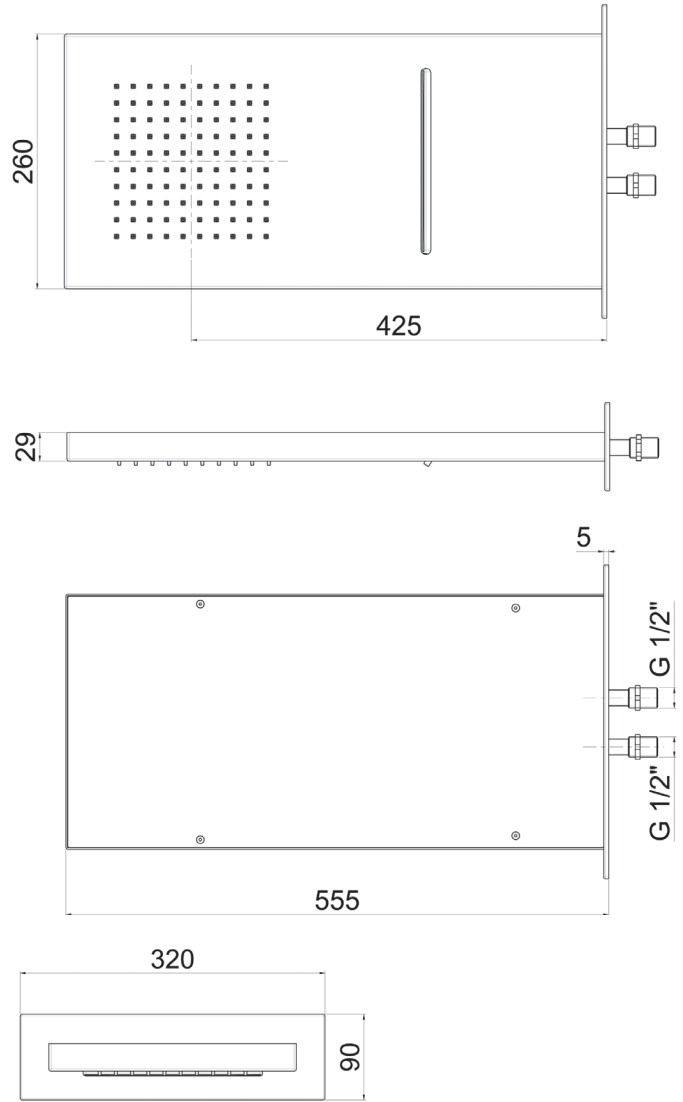
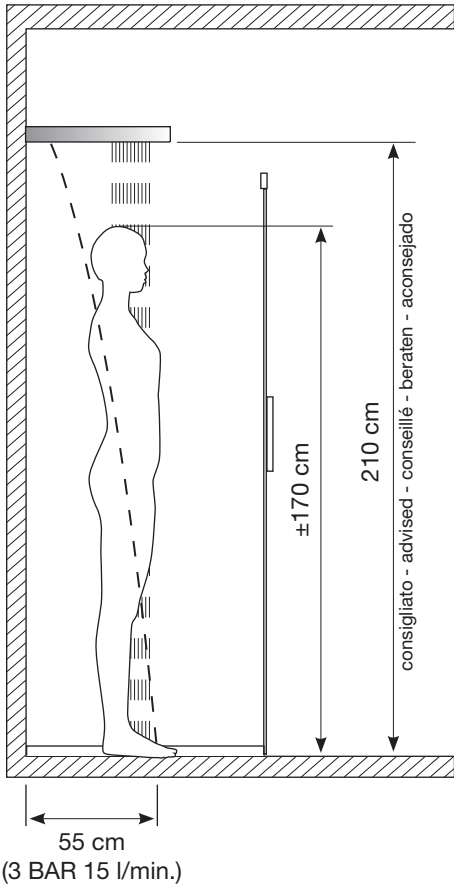

- | IT | Portata l/m cascata
- | GB | l/m waterfall flow
- | FR | Débit l/m cascade
- | DE | l/m Wasserfallfluss
- | ES | Caudal l/m cascada

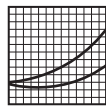

- | IT | Portata l/m pioggia
- | GB | l/m rain flow
- | FR | Débit l/m pluie
- | DE | l/m Regenfluss
- | ES | Caudal l/m lluvia

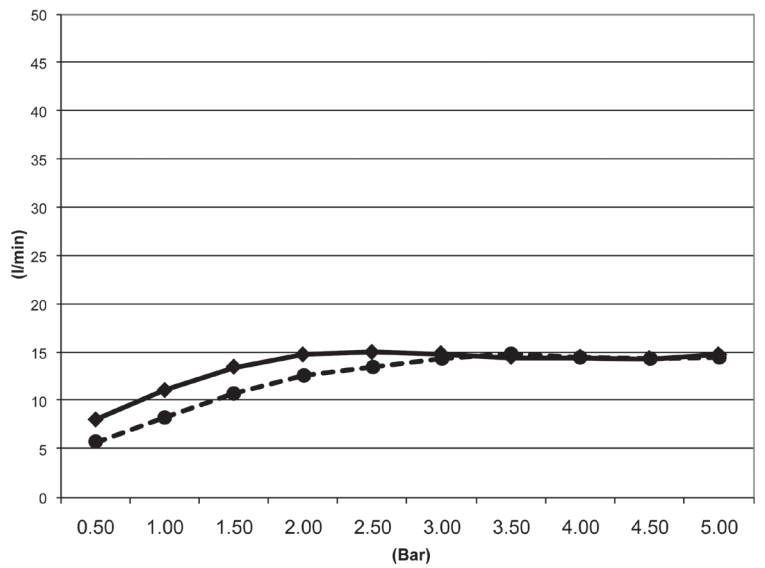

MIN 1 Bar

MAX 5 Bar

BEST 3 Bar

MAX 70° C

BEST 38°/40° C

	Pressione Dinamica (bar) / Portata (Litri/min)									
Bar	0,50	1,00	1,50	2,00	2,50	3,00	3,50	4	4,5	5
—◆—	8,1	11,2	13,5	14,8	15,1	14,9	14,5	14,5	14,4	14,8
-◆-	6,0	8,6	10,6	12,2	13,6	14,5	15,3	15,0	14,9	14,8

